

F1 Cylinder with trunnion mount

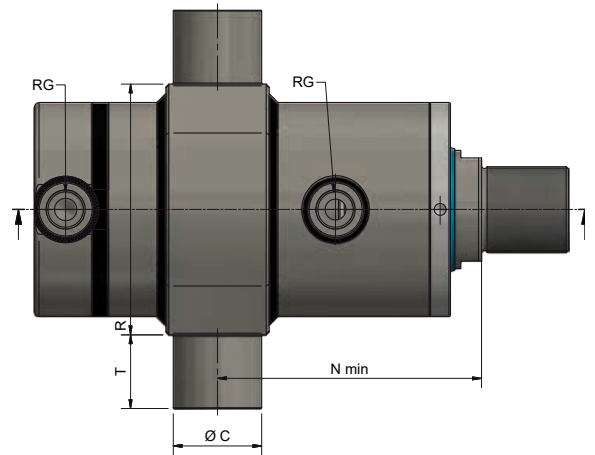
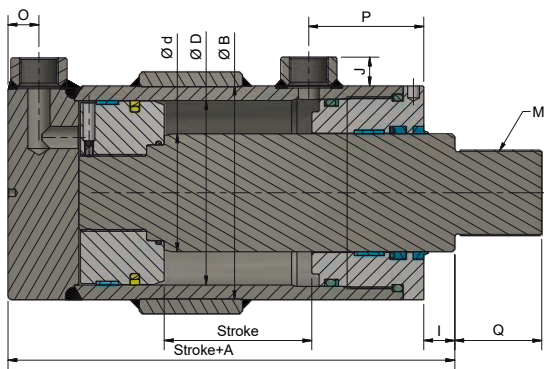

Dimension			INDEX												
D	d	B	A	C	T	R	Q	M	I	J	N	O	P	RG	
32	20	42	121	20	15	53	17	M16x1,5	10	13,5	102	14	45	1/4"	
40	20	50	121	25	17,5	70	17	M16x1,5	10	13,5	102	14	42	3/8"	
40	25	50	121	25	17,5	70	17	M16x1,5	10	13,5	102	14	42	3/8"	
50	25	60	134	30	20	80	17	M16x1,5	15	13,5	114	15	45	3/8"	
50	30	60	134	30	20	80	17	M16x1,5	15	13,5	114	15	45	3/8"	
50	35	60	134	30	20	80	17	M16x1,5	15	13,5	114	15	45	3/8"	
63	30	73	150	35	30	98	23	M22x1,5	15	16,5	125	16	53	1/2"	
63	40	73	150	35	30	98	23	M22x1,5	15	16,5	125	16	53	1/2"	
80	40	92	156	40	40	115	29	M28x1,5	14	16,5	136	18	59	1/2"	
80	50	92	156	40	40	115	29	M28x1,5	14	16,5	136	18	59	1/2"	
80	60	92	156	40	40	115	29	M28x1,5	14	16,5	136	18	59	1/2"	
100	50	115	184	50	40	135	36	M35x1,5	21	16,5	163	18	72	1/2"	
100	65	115	184	50	40	135	36	M35x1,5	21	16,5	163	18	72	1/2"	
100	80	115	184	50	40	135	36	M35x1,5	21	16,5	163	18	72	1/2"	
125	65	145	203	60	50	170	59	M58x1,5	21	19,5	179	21	78	3/4"	
125	80	145	203	60	50	170	59	M58x1,5	21	19,5	179	21	78	3/4"	
125	100	145	203	60	50	170	59	M58x1,5	21	19,5	179	21	78	3/4"	
140	70	160	239	70	55	195	59	M58x1,5	36	19,5	232	23	93	3/4"	
140	90	160	239	70	55	195	59	M58x1,5	36	19,5	232	23	93	3/4"	
160	80	185	266	75	65	210	66	M65x1,5	39	24,5	244	29	101	1"	
160	100	185	266	75	65	210	66	M65x1,5	39	24,5	244	29	101	1"	
180	90	205													
180	110	205													
200	100	230													
200	125	230													
220	125	254													
220	140	254													
250	125	298,5													
250	140	298,5													
250	160	298,5													
280	140	323,9													
280	160	323,9													
280	180	323,9													
300	160	355,6													
300	180	355,6													

Contact FJERO for solutions